

## accessories

### Main features

- easy and flexible handling
- combination of up to four slides per platform
- tight, but non-permanent connections
- connectors and plugs available in COC and PP



Microplate assembly platforms (MTF0204) are made of PC and allow to mount up to four microfluidic construction kit slides. Micro connectors and plugs are made of either COC or PP;

they allow to link the fluid ports on top of the slides with those of adjacent slides (slide connectors, SLC0405), with typical laboratory equipment such as syringes (micro luer connector, MLC0105) and

pipettes (micro pipette connector, MPC0105), or with standard tubes (micro fluid connector, MFC0204). Micro plugs (MPG0105), in turn, allow to block selected fluid ports.

### microplate assembly platform

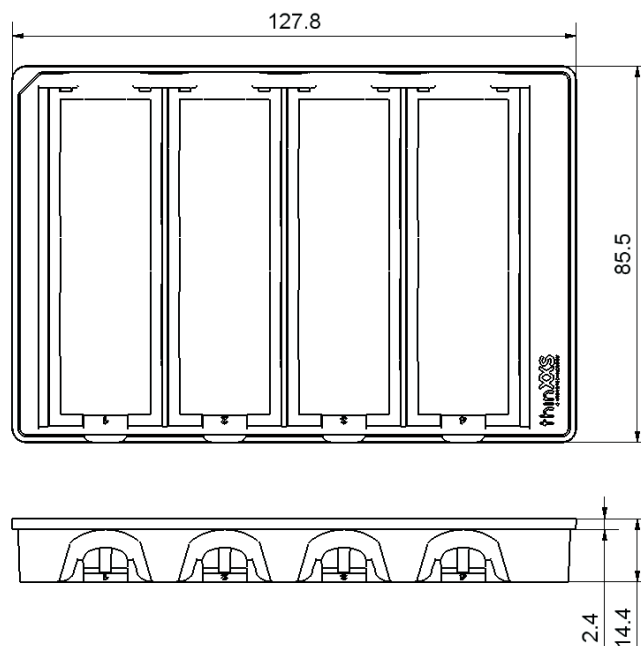

(all dimensions in mm)

**slide connectors**

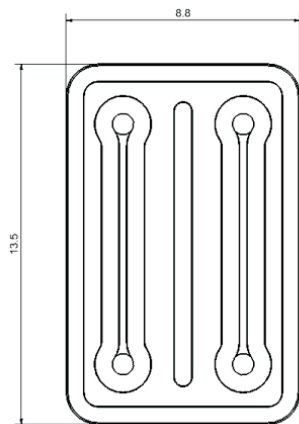

type 2x2

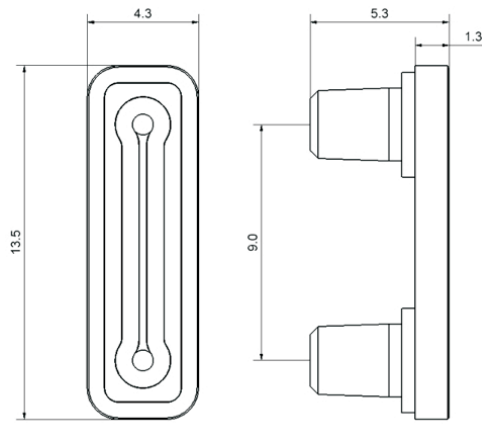

type 1x2

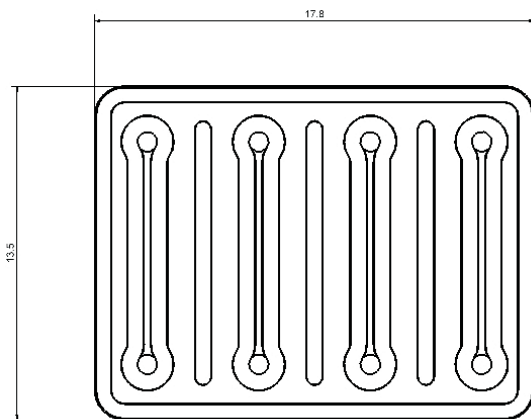

type 4x2

**lever**

(used to disconnect slide connectors)

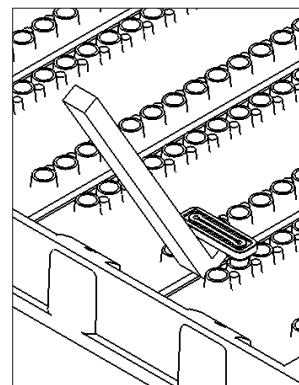

**micro luer connector**

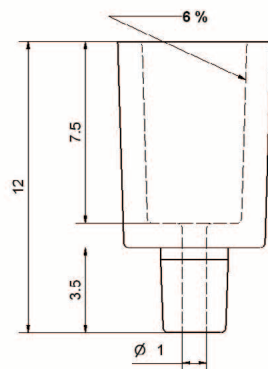

**micro pipette connector**

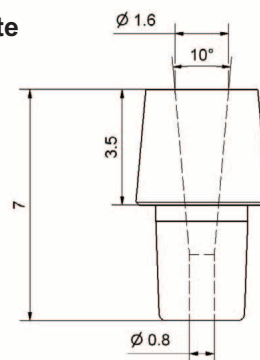

(all dimensions in mm)

## accessories

**micro fluid connector\***

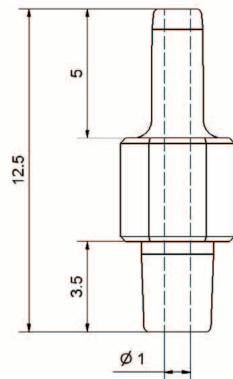

**micro plug**

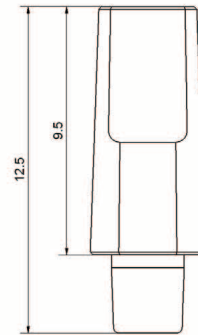

(all dimensions in mm)

### \*Recommended tubing

type:	Tygon	Silicone tube
inner diameter:	1.6 mm	1.0 mm
outer diameter:	3.2mm	3.0 mm
material:	PVC	silicone

### Order information

Description	Product code	Order code	Material	Quantity
Microplate Assembly Platform	MTF0204	TC02PC0401	PC	1
		TC02PC0405	PC	5
		TC02PC0410	PC	10
		TC02PC0425	PC	25
		TC02PC0450	PC	50
Slide Connector Set**	SLC0405	LC04CC0501	COC	1
Micro Luer Connector	MLC0105	LC01CC0525	COC	25
		LC01PP0525	PP	25
Micro Pipette Connector	MPC0105	LC02CC0525	COC	25
		LC02PP0525	PP	25
Micro Fluid Connector	MFC0204	LC02CC0425	COC	25
		LC02PP0425	PP	25
Micro Plug	MPG0105	LC03CC0525	COC	25
		LC03PP0525	PP	25

\*\* includes two type 4x2, four type 2x2, and four type 1x2 slide connectors (cf. previous page for types)